



Single handed, fast and accurate cutting

Permanently installed for immediate use, the Evolution3 BenchTop is perfect for a busy studio or high use production environment.

Keencut's unique Lift-and-Hover (patent pending) technology enables single-handed, fast and accurate alignment of all material, irrespective of thickness. Lower the clamping bar and it hovers just above the material surface with zero sag, even on the full length 3.6m (144") cutter. Use the sightline strip to see where the cut will be made, then fully engage the clamp – it's so simple.

You can rapidly change the QuikSwap heads to provide general cutting, creasing or fabric cutting, and you are always guaranteed ultra-high 0.2mm (0.008") precision accuracy with every cut.

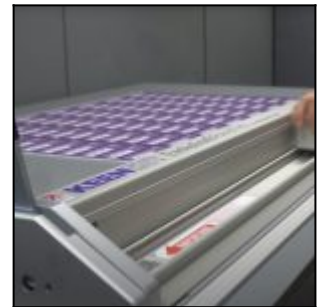
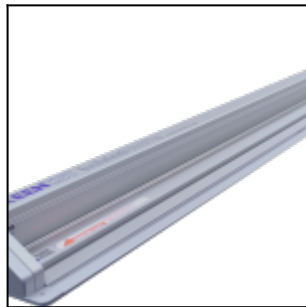

Materials cut

Semi-rigid materials

Corrugated cardboard ≤ 13mm (1/2")

PVC foamboard ≤ 13mm (1/2")

Corrugated plastic ≤ 13mm (1/2")

Foam centred board ≤ 13mm (1/2")

Rigid materials

Cast acrylic / Plexiglas ≤ 3mm (3/32") scoring only

Aluminium composite panel, e.g. DiBond ≤ 3mm (3/32") Rocker tool head only, for occasional use

Flexible materials

Banners

Pop-ups

Magnetic sheets

Film

Self-adhesive vinyls

Textiles

Delicate materials: tissue paper, wallpaper





Single handed operation

Two unique, patent pending features enable single-handed, fast and accurate alignment of all materials, irrespective of thickness. The Lift-and-Hover system enables the clamping bar to be easily raised and then lowered so it hovers just above the material surface. The anti-sag mechanism means the cutter bar can be suspended exactly parallel to the media surface over the whole length of the cut with zero sag.

Guaranteed accuracy

The Evolution3 is the most accurate cutter of its type on the market and is guaranteed to cut within 0.2mm (0.008") of a straight line for the full length of the cut. The in-built ultra-precision accuracy, combined with the perfect alignment made possible using the sightline strip, means every butt-jointed panel will join seamlessly. This ultra-precision accuracy will save you time and money with less waste and fewer mistakes.



Total stability

The self-adjusting track roller system fitted to the QuikSwap tool heads provides a strong and smooth movement up and down the length of the cutter bar, with zero sideways movement to ensure a perfect straight line. This, coupled with rigid blade clamping, gives perfect blade control and spot-on accuracy, so less wastage and mistakes.

Simple to use

The combination of the Lift-and-Hover and the sightline strip really does make cutting easier and faster than ever before. Testing has proven that the Evolution3 features increase accuracy and the speed of production. The ease of use makes it possible for even first time users to cut confidently and accurately.

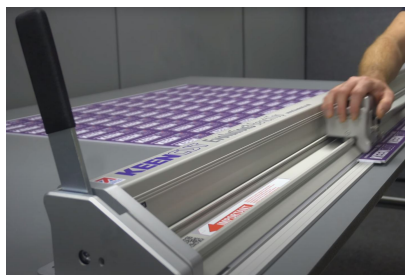

Heavy duty reliability

The entire Evolution3 range has been built to last using high quality materials and well tested engineering principles. The cutting head bearing system and clamping are tough enough to keep perfect blade control, even with the most difficult of materials. Keencut makes the majority of components on its precision CNC machines keeping tolerances and quality under constant control, this assures exceptional accuracy and total reliability.



QuikSwap Double Graphik tool head

The Evolution3 Double Graphik tool head comes as standard and has two individual blade holders for two-way cutting. The blades are stronger and more stable than regular blades making the Double Graphik tool ideal for vinyl, banner, cardboard, PVC foamboard up to 13mm (1/2"), foam-centred board, corrugated plastic, paper, pop-up and roll-up materials.

[Discover Evolution3 Double Graphik tool head >](#)



Optional Evolution3 tool heads



Evolution3 QuikSwap tool heads give users the ultimate flexibility. Each tool is designed for a specific purpose and can be attached or detached from the cutter in seconds

Evolution3 Fabric tool head is ideal for cutting fabric, paper, film, vinyl, banners and delicate materials. With the Evolution3 BenchTop and FreeHand, the Fabric tool head should be used in conjunction with a cutting mat. [Discover Evolution3 Fabric tool head >](#)

Evolution3 Rocker tool head is a general-purpose tool for cutting materials such as banners, cardboard and foamboard up to 10mm (3/8"). A Tech-D.012 blade can be used for the occasional cutting of aluminium composite panels, such as Dibond or Alupanel. [Discover Evolution3 Rocker tool head >](#)

Evolution3 Creaser tool head will crease in both directions and is ideal for stout paper, card, cardboard, and grey board. [Discover Evolution3 Creaser tool head >](#)

Five year guarantee

Like all Keencut machines, the Evolution3 is precision built using top quality materials. All components are manufactured in-house to ensure quality and all Evolution3 cutters come with a five year comprehensive guarantee. [Register your product to activate your guarantee >](#)



In the box

100 Graphik blades
Double Graphik tool head (mounted)



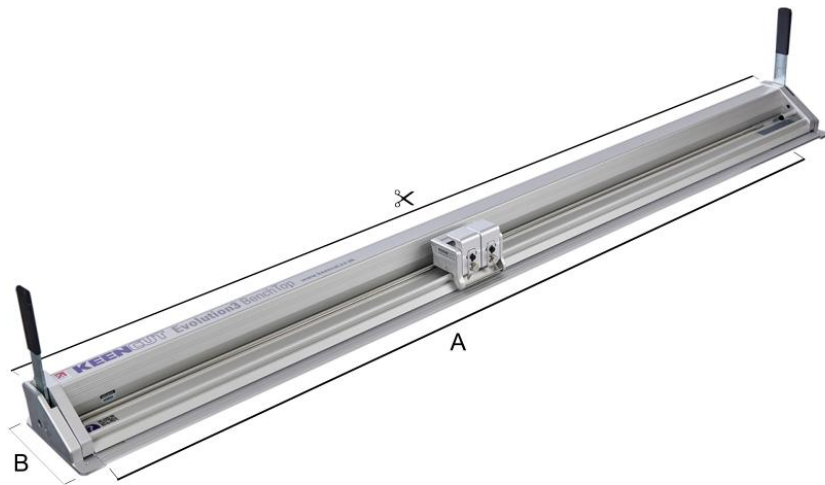

	E3BT110	E3BT160	E3BT210
Cut Length cm (")	110 (44)	160 (64)	210 (84)
A cm (")	148 (58)	198 (78)	248 (97.5)
B cm (")	20.5 (8)	20.5 (8)	20.5 (8)
Packed Weight KG (lbs)	27 (59.5)	34.5 (76)	42(92.5)
Packed Dimensions cm (")	160x35x17 (63x14x7)	210x35x17 (83x14x7)	260x35x17 (102x14x7)

	E3BT260	E3BT310	E3BT360
Cut Length cm (")	260 (104)	310 (124)	360 (144)
A cm (")	298 (117)	348 (137)	398 (157)
B cm (")	20.5 (8)	20.5 (8)	20.5 (8)
Packed Weight KG (lbs)	50 (110)	56 (123)	62.5 (138)
Packed Dimensions cm (")	310x35x17 (122x14x7)	360x35x17 (142x14x7)	410x35x17 (161x14x7)

